

*dal 1949 al servizio
della comunità odontoiatrica
ricerca e selezione
Qualità & Soluzioni
per voi!*

ilic SINCE 1949
QUALITY & VALUE

PERIODENT+

the barrier range

La gamma completa di guaine per
garantire la massima protezione
nella clinica quotidiana.

PERIODENT[®]+



Le barriere di qualità che abbiamo selezionato per voi!

Una delle principali aree di rischio nella diffusione delle malattie infettive è direttamente correlata alle superfici di uno studio dentistico.

Abbiamo selezionato queste guaine barriera usa e getta, prodotte utilizzando una plastica impermeabile, morbida e flessibile che impedisce ai batteri e alle infezioni di passare attraverso il materiale. Questa vasta gamma è disponibile in tutte le forme e dimensioni per soddisfare le vostre esigenze e ridurre la contaminazione crociata nello Studio.

INDICE

- Page 5** Guaine per siringa/HVE | 100B/100C
Guaine per i vassoi dello strumento | 101/102/190
- Page 6** Guaine a penna/manipoli | 103/104S/104L
Busta per pistola per impronte | 107
- Page 7** Busta per testa radiografico | 108/109
Copri poltrona/sgabello | 111/112
- Page 8** Copri poggiatesta | 113/114
Guaine a tubo | 118/119
- Page 9** Guaine per fotopolimerizzatrici | 123SS / 123S / 123L / 123XL
- Page 10** Guaine per Telecamera intraorale / guaine per lampada polimerizzante 125SS / 125 / 228
- Page 11** Guaine per guide luminose " Peel-n-Stick " | 128/129
Busta per mouse | 133S / 133L
Guaina per specchio intraorale | 140XS
- Page 12** Guaina per siringa di composito fluido | 138
Guaina con manica a T | 136/106
Guaina HVE / per tubi 135S / 135L
- Page 13** Guaina per sensori a raggi X | 140XS / 140S / 140M / 140L / 183-1 / 183-2
- Page 14** Guaina per bite-block | 145
Copri tastiera | 108/158S/158M
- Page 15** Buste barriera tipo PSP Dürr® | 188-0 / 188-1 / 188-2 / 188-3 / 188-4
- Page 16** Buste barriera tipo PSP Dürr® | 198-0 / 198-1 / 198-2
Buste barriera tipo PSP Digora® (Soredex®) | 189-0 / 189-1 / 189-2 PSP Carestream® (Kodak®) Tipo Buste barriera | 199-0 / 199-1 / 199-2
- Page 17** Copertina protettiva in carta 178-0 / 178-1 / 178-2
Rotoli di film barriera | 8008C/8008B
- Page 18-19** Informazioni sull'ordine

Evitare la contaminazione crociata

Esistono due metodi efficaci per evitare la contaminazione incrociata delle superfici in uno studio dentistico. Le superfici devono essere pulite e disinfettate dopo ogni paziente o sessione oppure devono essere applicate guaine barriera su tutte le superfici per evitare che la superficie venga contaminata in prima istanza. Quando una superficie è difficile da pulire con uno spray chimico o una salvietta, l'applicazione di manicotti barriera potrebbe essere una soluzione più utile.

Le guaine barriera possono limitare il numero di superfici che devono essere pulite e disinfettate tra un paziente e l'altro, fornendo una barriera impermeabile contro la contaminazione, che può quindi essere smaltita rapidamente e facilmente. Ciò consente di risparmiare tempo per il personale odontoiatrico, che è di vitale importanza all'interno di un programma intenso.

Le guaine barriera sono particolarmente utili in odontoiatria, in circostanze in cui:

- le superfici sono frequentemente toccate da professionisti che indossano guanti;
- le superfici siano contaminate da sangue o altri fluidi potenzialmente infetti;
- ci siano aree dello studio difficili da pulire e disinfettare (ad esempio, tra i tasti delle tastiere o i pannelli di controllo della poltrona).

I dentisti possono anche scoprire che le loro apparecchiature mediche avanzate non possono essere immerse nell'acqua per essere pulite o sterilizzate a causa del loro design complesso. L'uso di guaine barriera è un metodo eccellente ed efficace per proteggere questi dispositivi medici da sostanze chimiche aggressive e garantirne la longevità.

Le guaine barriera offrono molti vantaggi all'interno di uno studio dentistico:

- riducono il rischio di contaminazione crociata, proteggendo il personale e i pazienti; riducono i tempi di pulizia e disinfezione tra un paziente e l'altro;
- aumentano la longevità delle superfici grazie alla riduzione degli agenti chimici necessari; prevengono la contaminazione in aree difficili da pulire.
- Le barriere monouso possono essere facilmente rimosse e sostituite tra un trattamento e l'altro del paziente.

* Tutte le informazioni derivano da Molinari & Nelson. Ambiente protettivo Barriere superficiali nell'assistenza sanitaria. Il consulente dentale 2016.



Utilizzo di guaine monouso sleeves

Prima dell'applicazione

Le superfici e le attrezzature devono essere ispezionate per danni o contaminazione.

Se necessario, la superficie deve essere pulita e disinfettata.

Applicazione

Le superfici e le apparecchiature devono essere coperte con guaine barriera di forma e dimensioni adeguate. La barriera dovrebbe coprire completamente superfici o attrezzatura in modo da essere sicure quando in uso.

Dopo ogni paziente

Indossando i guanti, il manicotto barriera deve essere rimosso con cura e smaltito utilizzando una tecnica asettica. Tutte le superfici che sono venute a contatto con un paziente devono essere pulite e disinfettate.

Tutte le superfici sotto il manicotto di protezione che si sono infettate devono essere pulite e disinfettate. I guanti usati devono essere rimossi e sostituiti prima di applicare nuovi manicotti barriera.

Dopo ogni sessione

Pulire e disinfettare tutte le superfici secondo la normativa specifica del governo nazionale. Assicurarsi che durante il processo di pulizia e disinfezione vengano indossati dispositivi di protezione individuale adeguati.

* Tutte le informazioni derivate da Asepsi ambientale mediante barriere. Kerr TotalCare 2015.

syringe/HVE guaine sleeves

Utilizzate per siringhe a 3 vie, aspirasaliva e valvole HVE.
Apertura pretagliata per una facile applicazione. Disponibile in blu e trasparente. Cf. 500 pz.



100B Blue



100C Clear

vassoi portastrumenti sleeves

Gli strumenti possono essere posizionati direttamente sulla parte superiore della guaina. Cf. 500 pz.



101 Standard 'B'



102 Mini 'F'



190 Standard ISO

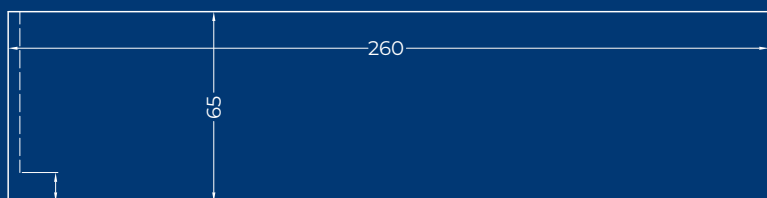

100B Blue 26 cm x 6.5 cm

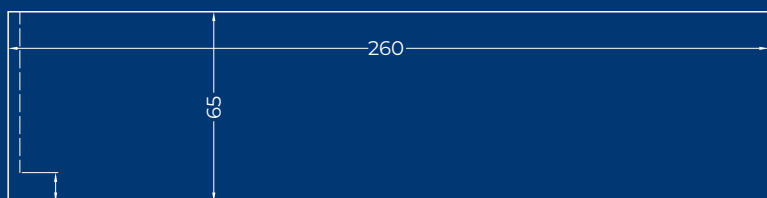

100C Clear 26 cm x 6.5 cm

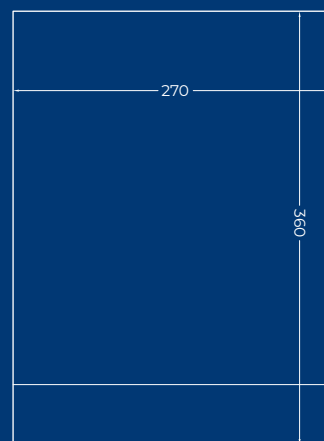

101 Standard 'B' 36 cm x 27 cm

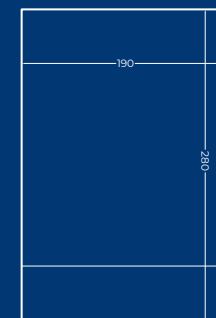

102 Mini 'F' 28 cm x 19 cm

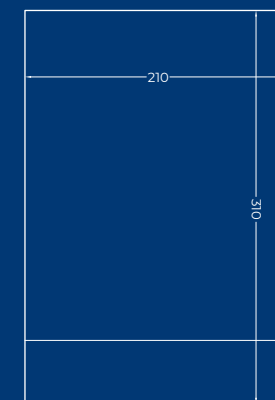

190 Standard ISO 31 cm x 21 cm

the barrier range

guaine a forma di penna e per manipoli sleeves

Per strumenti a forma di penna, manipoli e scalers per ultrasuoni.
Cf. 500 pz.



104L Low Speed / Universal Large



104L Low Speed / Universal Large



104S Low Speed / Universal Slim



103 Pen Shaped Instrument



104L Low Speed / Universal Large 22 cm x 4 cm



104S Low Speed / Universal Slim 22 cm x 3.8 cm



103 Pen Shaped Instrument 22 cm x 2.4 cm

guaine per pistola da impronta sleeves

Copre la cartuccia e il manico.
Fornisce protezione contro guasti o perdite della cartuccia.
Cf. 500 pz.



107 Universal

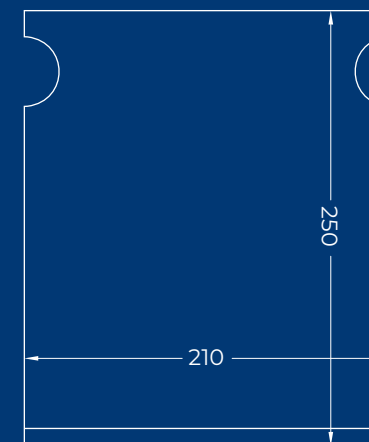

107 Universal 25 cm x 21 cm

x-ray sleeves

Per coprire la testa del radiografico.
Cf. 250 pz.



109 Large

copri poltrona sleeves

Elimina la necessità di copri poggiatesta separati. Prolunga la vita di poltrona e sgabello evitando il contatto diretto con disinfettanti e aerosol dannosi.
Cf. 125 pz.



111 Full Chair



108 Small 60 cm x 20 cm + 17 cm

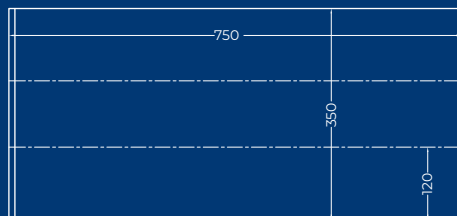

109 Large 75 cm x 35 cm + 24 cm



111 Full Chair 180 cm x 72 cm

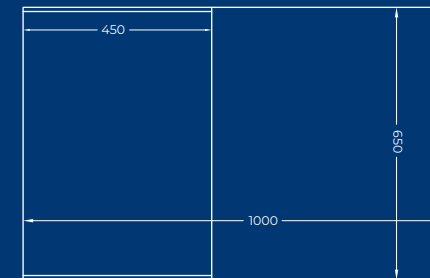

112 Half Chair/Stool 100 cm x 65 cm

the barrier range

copri poggiatesta sleeves

Crea una superficie pulita per consentire ai pazienti di appoggiare la testa con tranquillità. Cf. 500 pz.



114 Large

guaine per tubi sleeves

Per tubi dritti e a spirale.
366 metri / rotolo (1.200 piedi)



118 Tubing sleeve for straight tubing

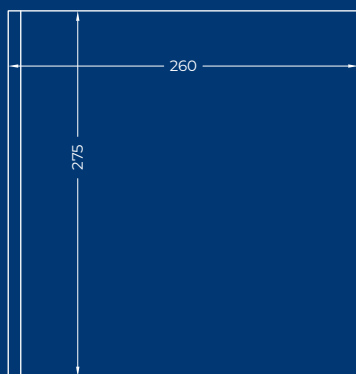

113 Small 27,5 cm x 26 cm

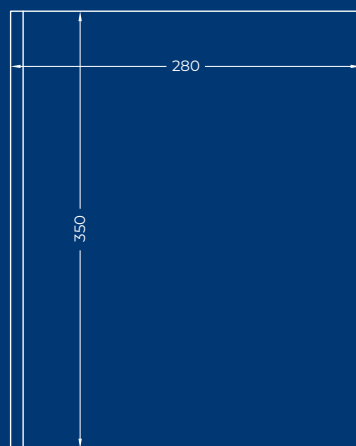

114 Large 35 cm x 28 cm

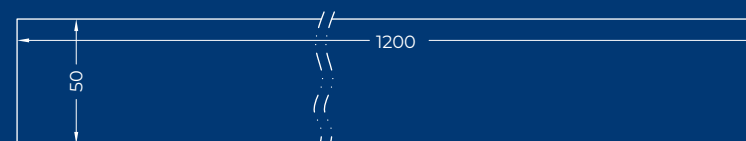

118 Tubing sleeve for straight tubing 2" / 5 cm wide

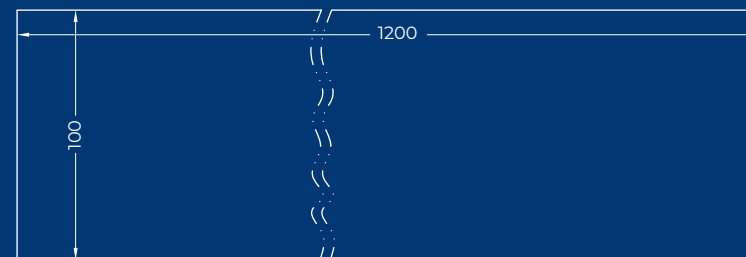

119 Tubing Sleeve for coiled tubing 4" / 10 cm wide

guaine per lampade sleeves

Una guaina per ogni tipo di lampada per polimerizzare.
Cf. 500 pz.

123XL Extra Large



123L Large



123S Small



123SS Small Short



123XL Extra Large 38 cm x 7.2 cm

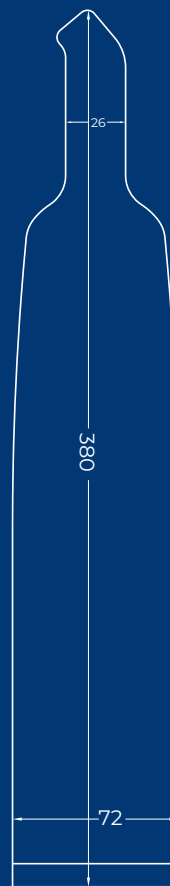

123L Large 35 cm x 6.5 cm



123S Small 32 cm x 5 cm



123SS Small Short 28 cm x 5 cm



telecamera intraorale/ lampada polimerizzante sleeves

Disponibile in un'ampia gamma di dimensioni per adattarsi alla maggior parte delle lampade fotopolimerizzatrici e delle telecamere intraorali .
Cf. 500 pz.

125SS Short



125 Standard



228 Mini Short



125SS Short 28 cm x 4,9 cm



125 Standard 32 cm x 4,9 cm



228 Mini Short 25 cm x 3,8 cm



peel-n-stick guide luminose sleeves

La linguetta staccabile assicura che la guida luminosa possa essere completamente racchiusa e sigillata dalla guaina barriera. Cf. 200 pz.

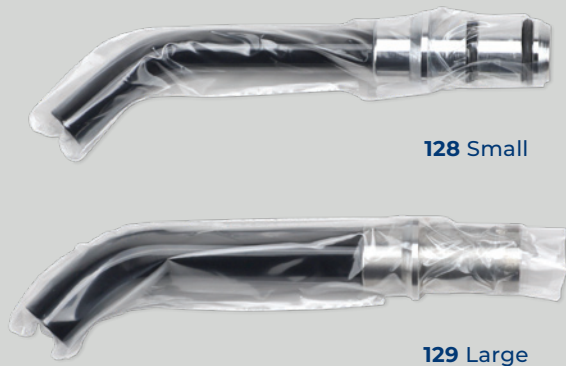

128 Small

129 Large

per mous del pc sleeves

Guaine per mouse del pc.
Due misure disponibili per mouse ottici con o senza cavo.
Cf. 500 pz.



133S Small

133L Large

per specchietto intraorale sleeves

Realizzato in poli plastica molto morbida per una maggiore sensazione tattile.
Cf. 500 pz.

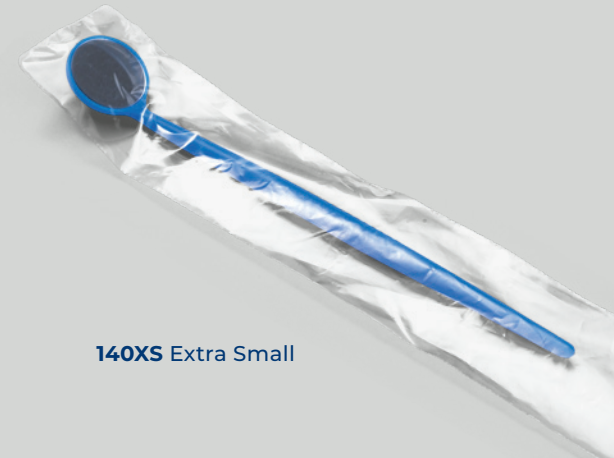

140XS Extra Small

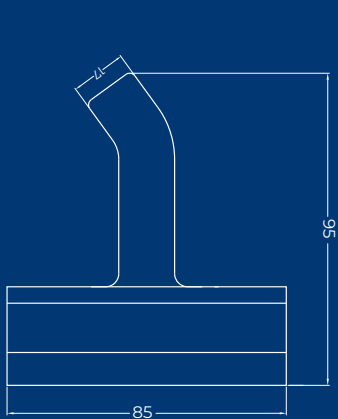

128 Small (fits 7-8 mm light guide)

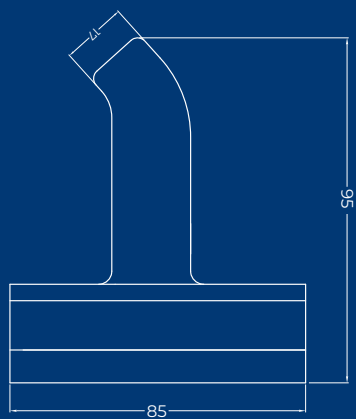

129 Large (fits 9-11 mm light guide)

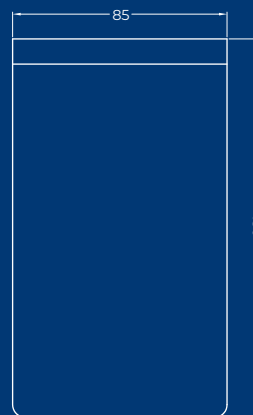

133S Small 15 cm x 8.5 cm

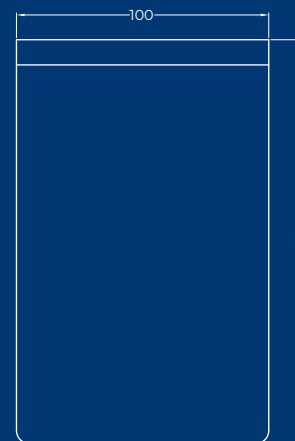

133L Large 16 cm x 10 cm

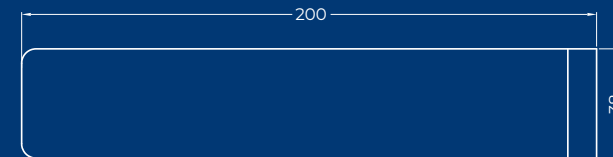

140XS Extra Small 20 cm x 3.8 cm

siringhe per compositi fluidi sleeves

Adatto anche per altri materiali fluidi che utilizzano una siringa con punta applicatrice, come mordenzanti, sigillanti e sottofondi di cavità. Cf. 200 pz.



138 Universal

maniglie per lampada sleeves

Misura universale per adattarsi alla maggior parte di maniglie a "t"
Cf. 500 pz.



106 T-Shape



136 Rectangular

HVE sleeves

Pretagliata per un'applicazione più semplice
Cf. 500 pz.

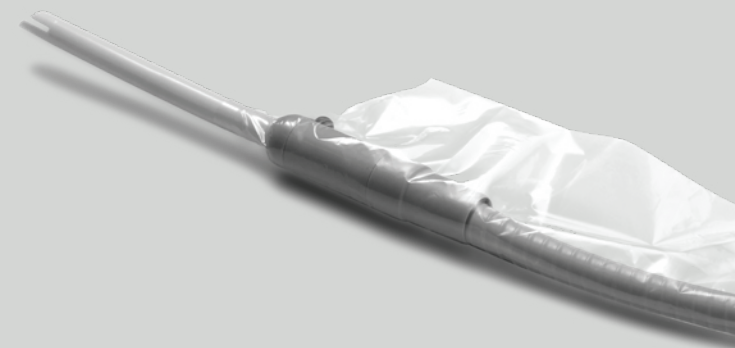

135S Small

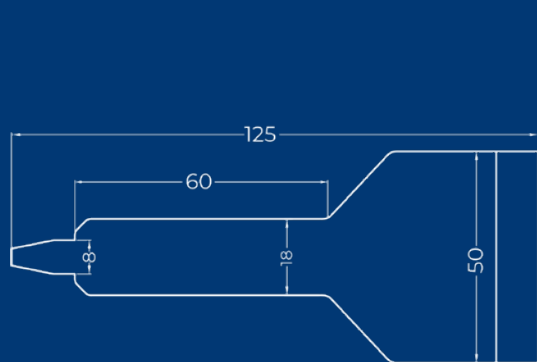

138 Universal 12.5 cm x 5 cm

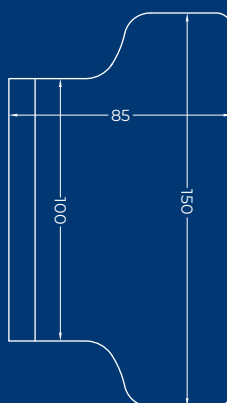

106 T-Shape 15 cm x 8.5 / 10 cm

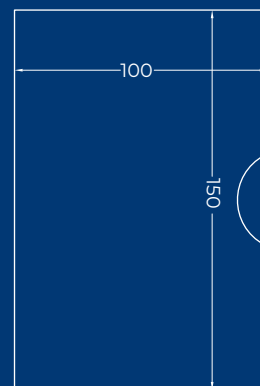

136 Rectangular 15 cm x 10 cm

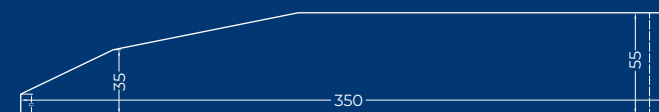

135S Small (for 11 mm tube) 36 cm x 5.5 cm

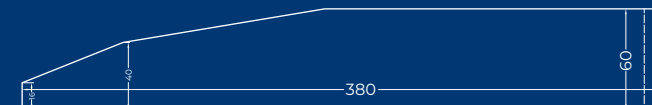

135L Large (for 16 mm tube) 38 cm x 6 cm

x-ray sensor sleeves

Eccellente protezione per preziosi sensori a raggi X.
 Queste guaine per sensori a raggi X sono compatibili
 con quasi tutti i sistemi a raggi X.
 Cf. 500 pz.



Standard Sensor Sleeve



Two Step Sensor Sleeves

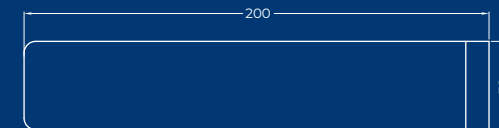

140XS Extra Small 20 cm x 3.8 cm

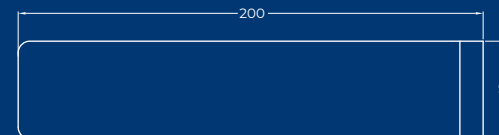

140S Small 20 cm x 4.2 cm

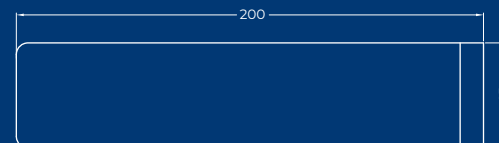

140M Medium 20 cm x 4.5 cm

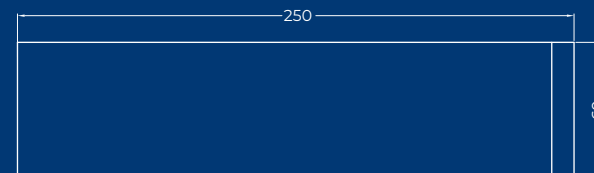

140L Large 25 cm x 6 cm

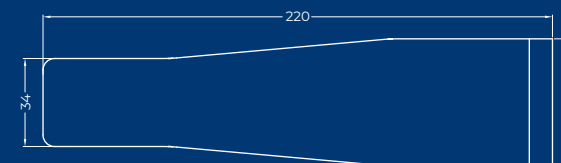

183-1 Size 1 22 cm x 3.4 cm / 50 mm

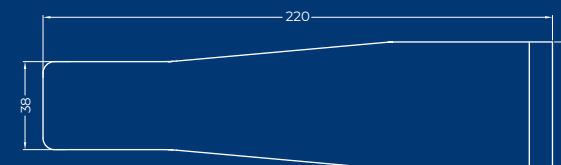

183-2 Size 2 22 cm x 3.8 cm / 55 mm

bite block sleeves

fogli per 3D bite block
Cf. 1000 pz.



145 Universal

copertura per tastiera sleeves

Fornisce protezione dalla contaminazione crociata senza interferire con i movimenti



158S Standard



158M Medium



158L Large

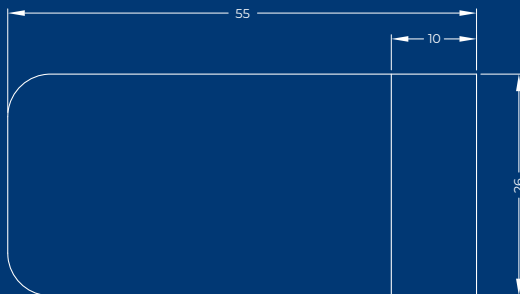

145 Universal 5.5 cm x 2.6 cm

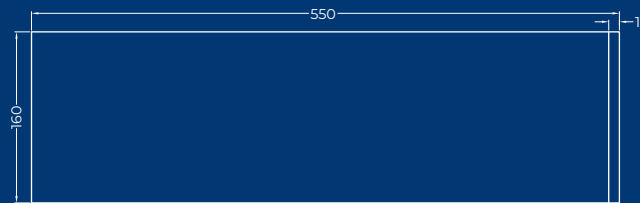

158S Standard 55 cm x 16 cm (500 pieces / box)

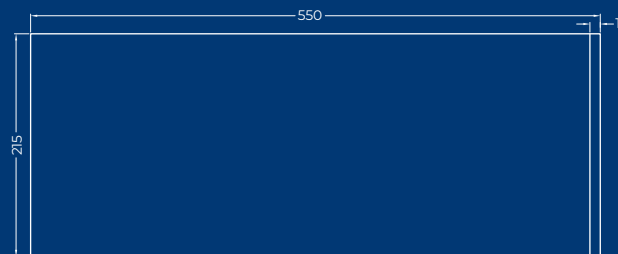

158M Medium 55 cm x 21.5 cm (250 pieces / box)

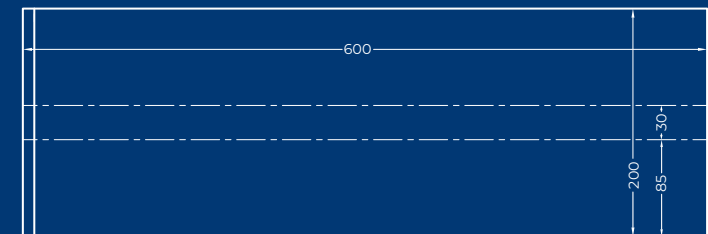

108 Large 60 cm x 20 cm + 17 cm (250 pieces / box)

PSP buste tastiera envelopes

Coperture di protezione dalla luce progettate per adattarsi alle lastre al fosforo più diffuse. Realizzata in morbido vinile con angoli arrotondati, la rapida apertura a strappo rende ideali per l'uso quotidiano in ambulatorio. Tutte le misure sono quelle interne.



Dürr® Type Mid-Opening Barrier Envelopes

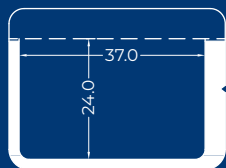

188-0 Size 0
37 mm x 24 mm
(100 pieces / box)

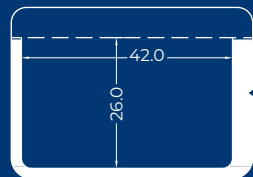

188-1 Size 1
42 mm x 26 mm
(100 pieces / box)

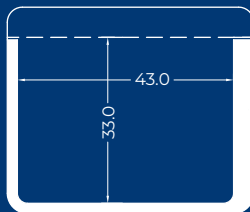

188-2 Size 2
43 mm x 33 mm
(100 pieces / box)

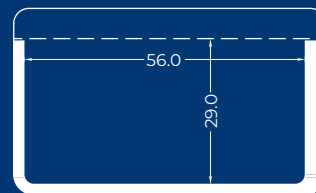

188-3 Size 3
56 mm x 29 mm
(50 pieces / box)

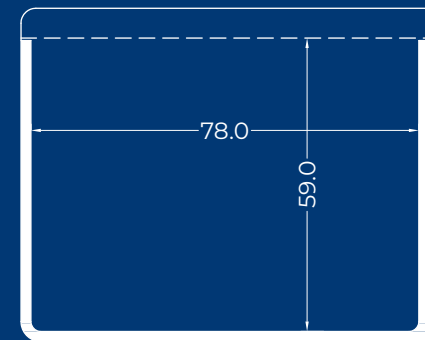

188-4 Size 4
78 mm x 59 mm
(50 pieces / box)

the barrier range



Dürr® Type Top-Opening Barrier Envelopes



Digora® (Soredex® Type) Top-Opening Barrier Envelopes



Kodak® (Carestream® Type) Top-Opening Barrier Envelopes

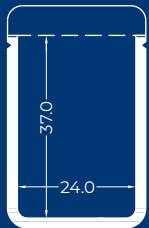

198-0 Size 0
24mm x 37mm
(100 pieces / box)

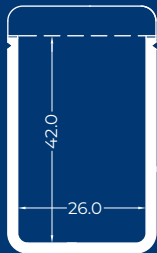

198-1 Size 1
26mm x 42mm
(100 pieces / box)

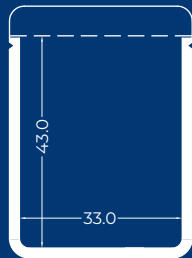

198-2 Size 2
33mm x 43mm
(100 pieces / box)

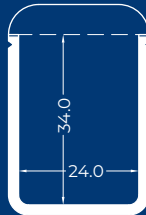

189-0 Size 0
24mm x 34mm
(100 pieces / box)

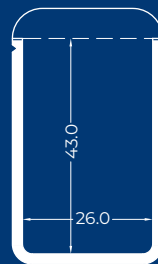

189-1 Size 1
26mm x 43mm
(100 pieces / box)

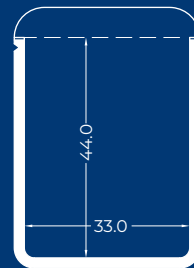

189-2 Size 2
33mm x 44mm
(100 pieces / box)

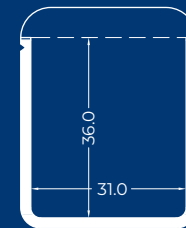

199-0 Size 0
31mm x 36mm
(100 pieces / box)

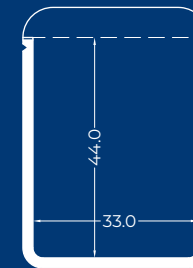

199-1 Size 1
33mm x 44mm
(100 pieces / box)

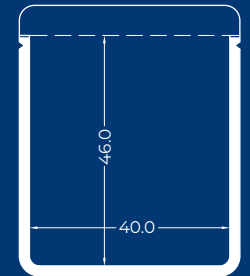

199-2 Size 2
40mm x 46mm
(100 pieces / box)

copertura protettiva in carta cover

Copertura di carta progettata per proteggere le lastre al fosforo quando vengono posizionate all'interno di una busta barriera. Cf. 100 pz.

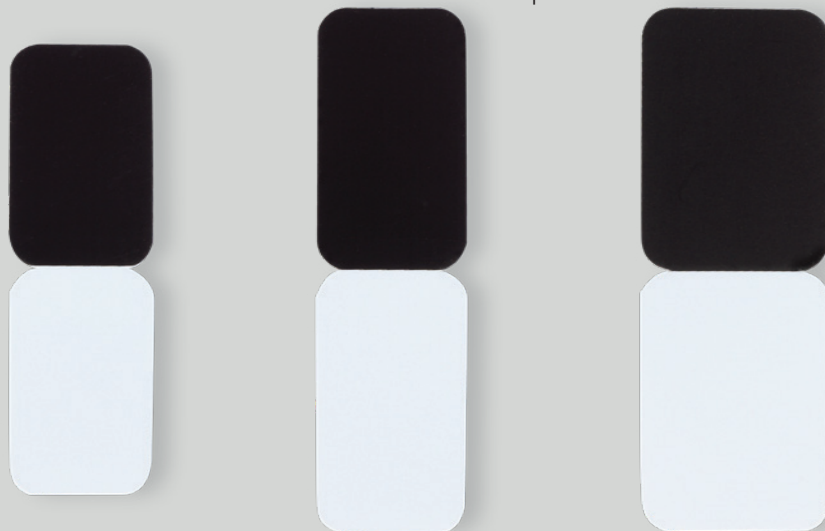

178-0 Size 0

178-1 Size 1

178-2 Size 2

pellicola barriera film

Con bordo non adesivo per una rapida rimozione. Il nostro film barriera non lascia residui quando viene rimosso. Rotolo da 1200 strappi

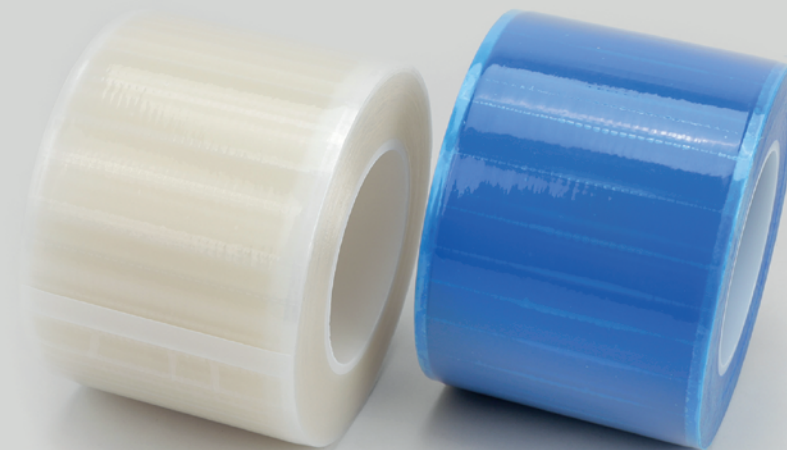

8008C Clear

8008B Blue

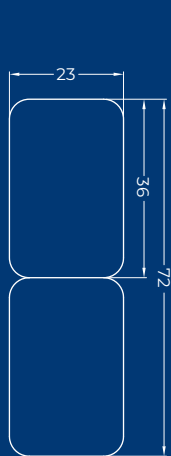

178-0 Size 0 2 x 23 mm x 36 mm

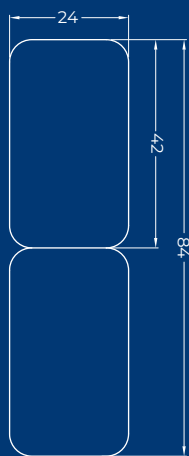

178-1 Size 1 2 x 24 mm x 42 mm

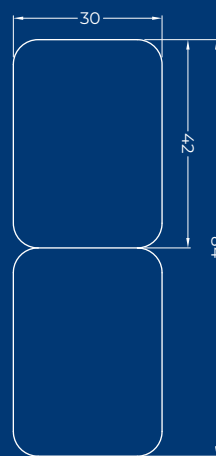

178-2 Size 2 2 x 30 mm x 42 mm

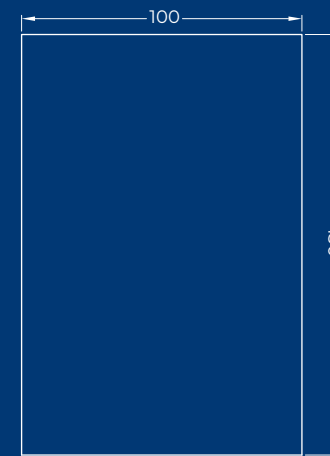

8008C Clear / 8008B Blue 10 cm x 15 cm

Order information

Codice	Descrizione	Confezione
100B	100B Syringe Sleeves 500s Blue	500 pcs/box
100C	100C Syringe Sleeves 500s Clear	500 pcs/box
101	101 Standard Tray Sleeves 500s	500 pcs/box
102	102 Mini Tray Sleeves 500s	500 pcs/box
103	103 High Speed Sleeves 500s	500 pcs/box
104L	104L Low Speed Sleeves 500s	500 pcs/box
104S	104S Low Speed Sleeves 500s	500 pcs/box
106	106T Light Handle Sleeves 500s	500 pcs/box
107	107 Impression Gun Sleeves 500s	500 pcs/box
108	108 Small X-Ray Sleeves 250s	250 pcs/box
109	109 Large X-Ray Sleeves 250s	250 pcs/box
111	111 Full Chair Sleeves 125s	125 pcs/box
112	112 Half Chair/Stool Sleeves 125s	125 pcs/box
113	113 Headrest Sleeves 500s Small	500 pcs/box
114	114 Headrest Sleeves 500s Large	500 pcs/box
118	118 Tube Sleeve 1200ft roll 5cm	366 m/roll
119	119 Tube Sleeve 1200ft roll 10cm	366 m/roll
123L	123L Pen Type Curing Light Sleeves 500s Large C01-S/D	500 pcs/box
123S	123S Pen Type Curing Light Sleeves 500s Small C01-C	500 pcs/box
123SS	123SS Pen Type Curing Light Sleeves 500s Small Short C01-C	500 pcs/box
123XL	123XL Pen Type Curing Sleeves 500s Extra Large	500 pcs/box
125	125 Intraoral Camera/RA Curing Light Sleeves 500s C02-C/S/D	500 pcs/box
125SS	125SS Intraoral Camera/RA Curing Light Sleeves 500s Small Short C02-C/D	500 pcs/box
128	128 Light Guide Sleeves 200s Small	200 pcs/box
129	129 Light Guide Sleeves 200s Large	200 pcs/box
133L	133L PC Mouse Sleeves 500s Large	500 pcs/box
133S	133S PC Mouse Sleeves 500s Large	500 pcs/box
135L	135L HVE Suction Tube Sleeves 500s Large	500 pcs/box
135S	135S HVE Suction Tube Sleeves 500s Small	500 pcs/box

Codice	Descrizione	Confezione
136T	136 T Handle Sleeves 500s	500 pcs/box
138	138 Composite Syringe Sleeves 200s	200 pcs/box
140L	140L X-Ray Sensor Sleeves 500s Large	500 pcs/box
140M	140M X-Ray Sensor Sleeves 500s Medium	500 pcs/box
140S	140S X-Ray Sensor Sleeves 500s Small	500 pcs/box
140XS	40XS X-Ray Sensor Sleeves 500s Extra Small	500 pcs/box
145	145 Bite Block Sleeves 1000s	1000 pcs/box
158	158 Standard Keyboard Sleeves 500s Small	500 pcs/box
158M	158M Standard Keyboard Sleeves 250s Medium	250 pcs/box
1831	183-1 Two Step X-Ray Sensor Sleeves 500s	500 pcs/box
1832	183-2 Two Step X-Ray Sensor Sleeves 500s	500 pcs/box
1880	188-0 Barrier Envelopes 100s No. 0	100 pcs/box
1881	188-1 Barrier Envelopes 100s No. 1	100 pcs/box
1882	188-2 Barrier Envelopes 100s No. 2	100 pcs/box
1883	188-3 Barrier Envelopes 50s No. 3	50 pcs/box
1884	188-4 Barrier Envelopes 50s No. 4	50 pcs/box
1890	189-0 Barrier Envelopes 100's No.0	100 pcs/box
1891	189-1 Barrier Envelopes 100's No.1	100 pcs/box
1892	189-2 Barrier Envelopes 100's No.2	100 pcs/box
190	190 ISO Tray Sleeves 500s	500 pcs/box
1980	198-0 Barrier Envelopes 100s No.0	100 pcs/box
1981	198-1 Barrier Envelopes 100s No.1	100 pcs/box
1982	198-2 Barrier Envelopes 100s No.2	100 pcs/box
1990	199-0 Barrier Envelopes 100's No.0	100 pcs/box
1991	199-1 Barrier Envelopes 100's No.1	100 pcs/box
1992	199-2 Barrier Envelopes 100's No.2	100 pcs/box
228	228 Pen Type Curing Light Sleeves 500s C01/2M	500 pcs/box
1780	178-0 Protective Covers 100s No.0	100 pcs/box
1781	178-1 Protective Covers 100s No.1	100 pcs/box
1782	178-2 Protective Covers 100s No.2	100 pcs/box
8008B	8008 Barrier Film 10cm x 15cm Blue	1200 sheets/roll
8008C	8008 Barrier Film 10cm x 15cm Clear	1200 sheets/roll

Per ordinare: ilic@ilicdental.com - tel +39 02 36 512 990				
Cliente				
Indirizzo				
Città	CAP	Prov	Tel	Cell
Ind. consegna				Codice SDI
P.IVA	C.Fisc.	e-mail		

CODICE	RIF	PRODOTTO/DESCRIZIONE	PREZZO cad.	Q.TÀ	OFFERTA

Giorni di apertura: Mattino L M M G V S Pomeriggio L M M G V S

Contributo spese spedizione: Ordini superiori a € 130,00 (IVA esc.) nessun contributo spese
Ordine fino a € 130,00 (i.e.) + € 13,00 - inferiori a € 75,00 (i.e.) + € 16,00

PAGAMENTO: Ordini inf. a € 130,00 (i.e.): Contrassegno (+ € 6,50) Bonifico anticipato Carta di credito o POS
 Ordini sup. a € 130,00 (i.e.): Contrassegno (+ € 6,50) R.B. 30 gg. d.f. Carta di credito o POS

IBAN Ivan Ilic' srl: IT50N0569601625000003415X03 **IBAN Cliente:**

Carta di credito o POS Visa Mastercard Numero Scadenza

DATA **TIMBRO E FIRMA**

Ai sensi della legge 196/03 le rammentiamo l'esistenza dei diritti che la legge stessa riserva ai titolari dei dati personali e, in particolare del diritto di verifica e di richiederne la cancellazione. Con la compilazione della presente cartolina, Lei acconsente alla raccolta dei dati forniti e alla loro comunicazione ai nostri partner commerciali al fine di poter ricevere informazioni e offerte commerciali. In caso di dissenso barri la casella qui a fianco.

PERIODENT⁺

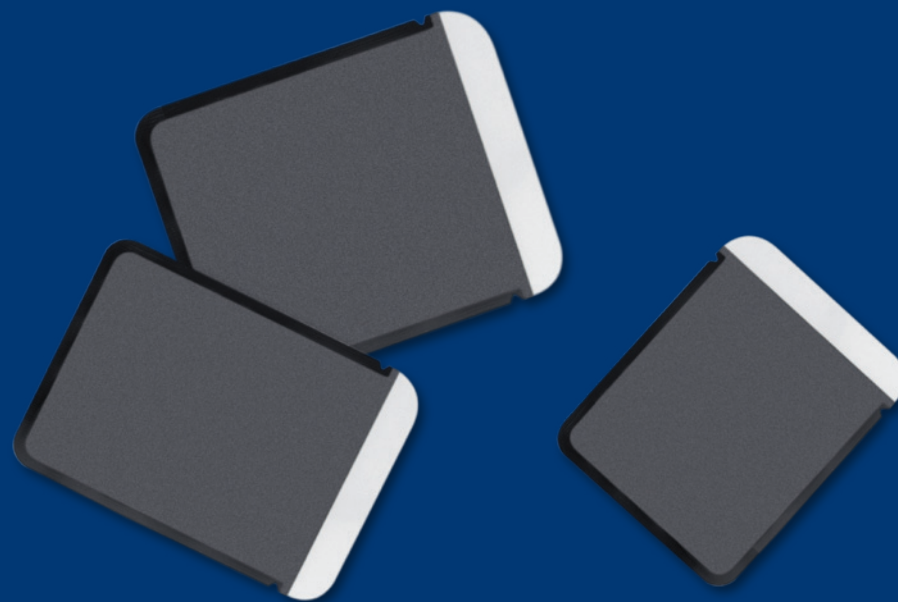

IVAN ILIC' srl

Via L. Muratori, 46/11 - 20135 Milano (Italy)

TEL: +39 02 36 512 990 FAX: +39 02 55 016 646

ilic@ilicdental.com



ilicdental.com